



VANMASS®

USER MANUAL



service@vanmasslife.com



www.vanmass.com



[@vanmasslife](https://www.facebook.com/vanmasslife)



+86 18677532232



INSTALLATION VIDEOS

Installation Instructions

I. Phone Mount Assembly

1. Unscrew the nut from the phone holder

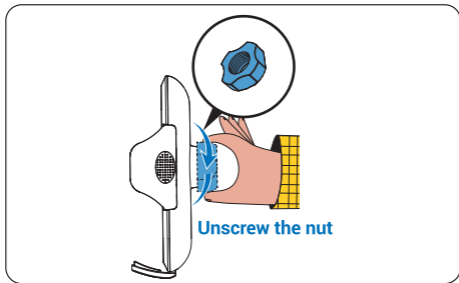

2. Insert the nut into the ball joint

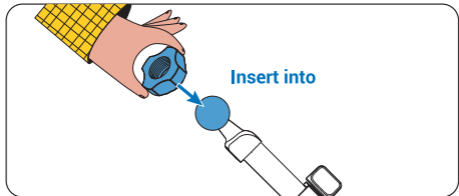

3. Push the ball joint into the groove of the holder

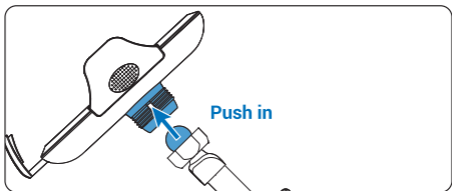

4. Make sure the ball joint is fully in the groove and then tighten the nut

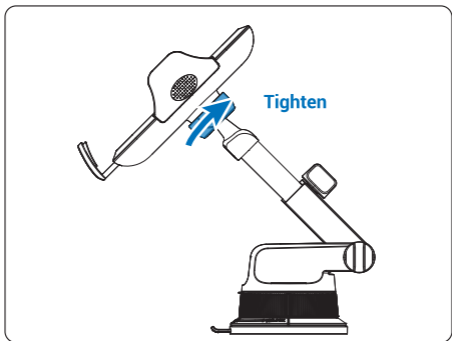

II. Installation Spot

Optional Installation Spots

Flat dashboard or windshield, vertical or horizontal air outlet

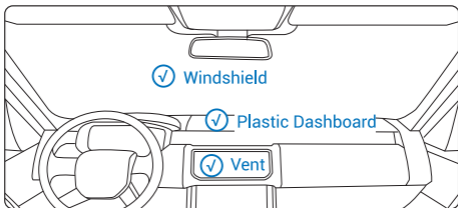

⚠ Practical Tips

Leather or textile dashboard: NOT compatible, in case of any damage.

In extreme summer heat: It is recommended to install the suction cup away from the direct sunlight.

Clean the flat attaching surface



1. Wipe with Wet



2. Wipe with Dry



1. Please make sure the attaching surface is flat, curved mounting surfaces reduce adhesion.

2. Wipe the attaching surface, wet tissue first, dry tissue later.

III. Suction Cup Installation

1. Peel off the protective film



2. **Firmly** press the suction cup for 10 seconds

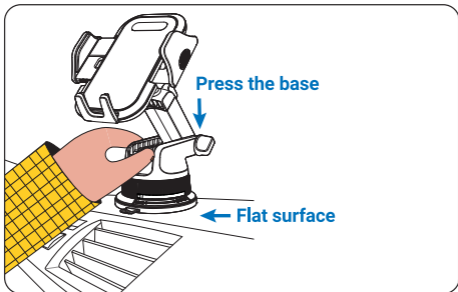

3. **Keep** pressing while rotating the base clockwise from the "UNLOCK" icon

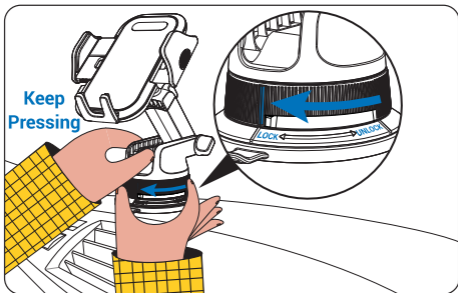

4. Keep rotating until it's **completely** aligned with the "LOCK" icon

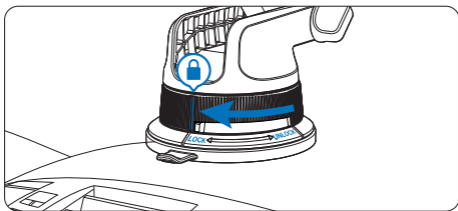

IV. Phone Mount Adjustment

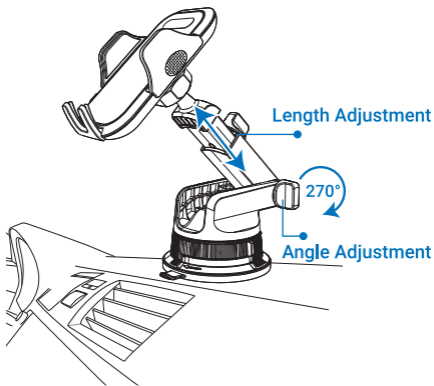

Please wait 15 minutes before placing your phone, for higher adhesion.

V. Phone Mount Usage

Release the arms

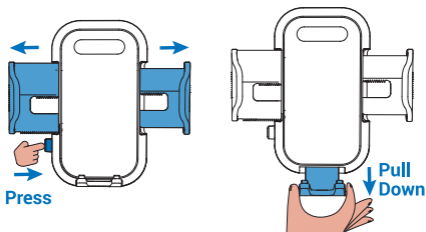

Clamp the arms

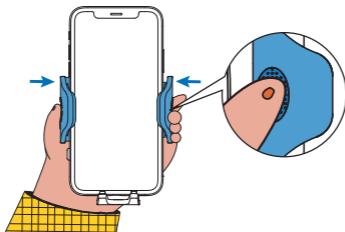

FAQs

1. How to make the suction cup stick again?

Please rinse the suction cup bottom, air dry it, clean the attaching surface and then install the suction cup directly on a flat spot.

2. Do I need to return the product for a replacement or refund?

No, because our product has a 36-month free warranty for any product issues.

3. Any other questions like below, please reach our service at service@vanmasslife.com.

Vent clip installation, suction cup remove tips, product improvement suggestions.